

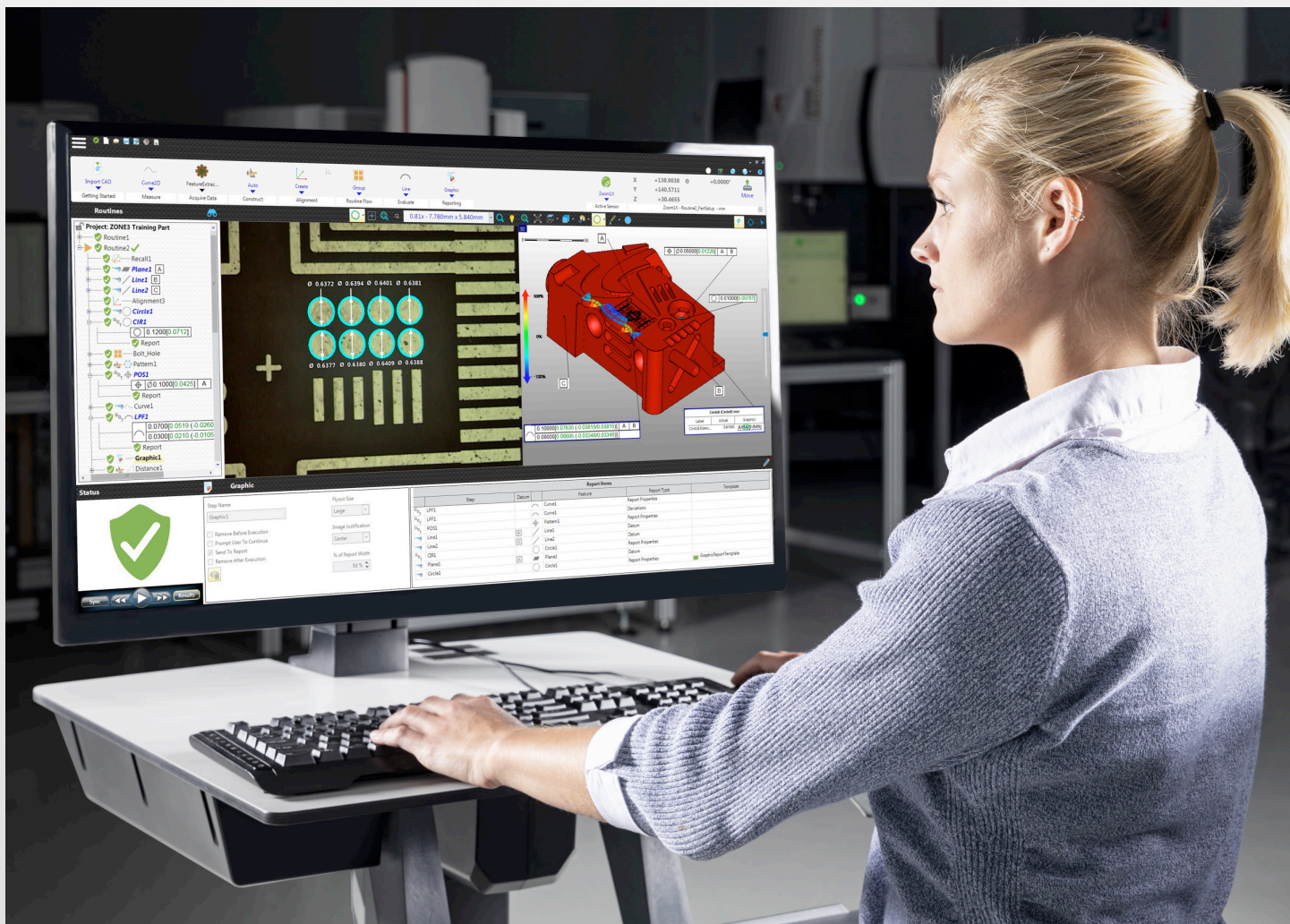

ZONE3

3D Multisensor Metrology Software



ZONE3 and OGP - Put 30+ Years of Multisensor Experience to Work for You



ZONE3® metrology software puts the power of OGP®'s 30 years of multisensor experience into your measurement system for faster, easier and more productive measurements than ever before.

Fast – Full field image processing and high-speed cameras allow entire scenes to be measured instantly.

Capable – Full multisensor capability, including scanning laser and scanning probe support, GD&T and custom scripting.

Easy – Alignments, measurements and constructions are shown graphically in real time, regardless of which member of the ZONE3 family you use — Express, Prime, Pro or Offline.



ZONE3 integrates seamlessly with other OGP metrology applications through the Portal. You can retain a library of OGP MeasureMind® 3D and Measure-X® routines and continue to run them from within their native applications, while taking advantage of new and advanced capabilities by adding ZONE3 to your existing SmartScope® multisensor systems.

MeasureMind3D to ZONE3 Translator

ZONE3 offers a time-saving method to convert a MeasureMind3D routine into a ZONE3 project. You can open a MeasureMind3D routine file (.rtn) in ZONE3, examine the generated part routine consisting of converted steps, edit the steps as needed, and save the resulting ZONE3 project file (.qpf).

Measure-X to ZONE3 Exporter

The ability to export a Measure-X routine into a ZONE3 format is available, providing a means to assist in migrating programs to ZONE3. Simply open the export file (.mxz) generated from Measure-X in ZONE3, edit the routine as needed, and save the resulting ZONE3 project file (.qpf).

The ZONE3 Process

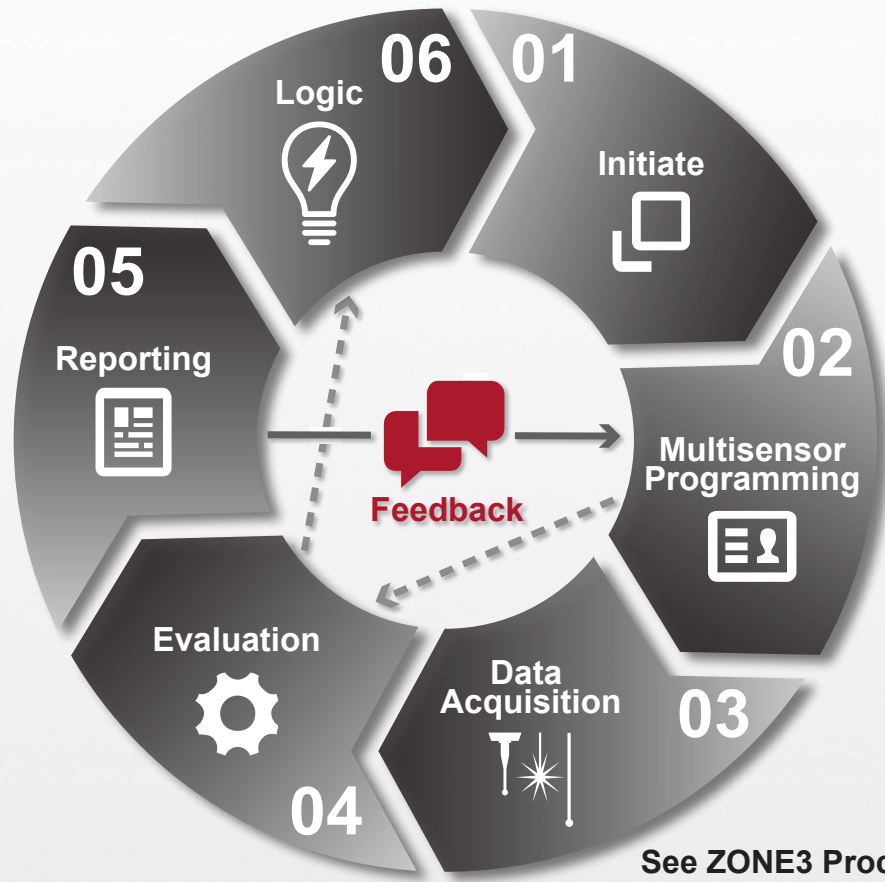



Initiate

Manual Measurement

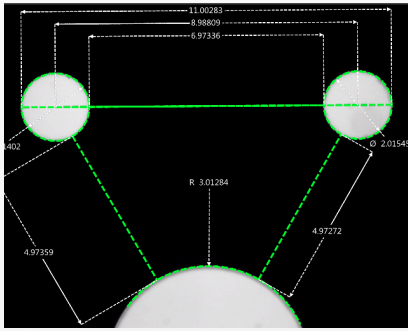

Use manual targets to make quick and easy walk up measurements.

- No need to set up a part or import a CAD file.
- Manual measurements can be read directly off the DRO.

Use **FeatureExtractor** to automatically identify and measure features visible within the FOV.

- With one click, all prominent features are displayed as flyouts in the video window.
- Hover over features to see relationships to other geometries.
- Found features can be used for quick measurements or to automate the programming of a production part.

Part Identification

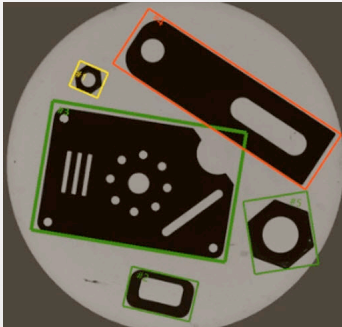

Use **AutoID** to automatically run a routine. ZONE3 will search for and automatically run part routines that match the part(s) that you have placed on the machine stage and are visible within the video window.

- ZONE3 compares the outlines of parts to the thumbnail images of parts whose routines have been registered in the AutoID database.
- ZONE3 then runs the default part routine associated with each identified part.

Video Align to CAD

The **Reposition via Video** tool* can be used to automatically align using a CAD model.

- A trace is performed on the outer boundary of a part and the CAD model is automatically adjusted to the appropriate position and orientation.
- If the part does not fit within the FOV, the stage will automatically move to capture the entire outer boundary.

Operator Interface

LaunchPad is a simplified yet highly configurable user interface where users with minimal training can launch and run programs.

- Setup instructions, documents, videos, barcode identification, etc., can be added to each program.

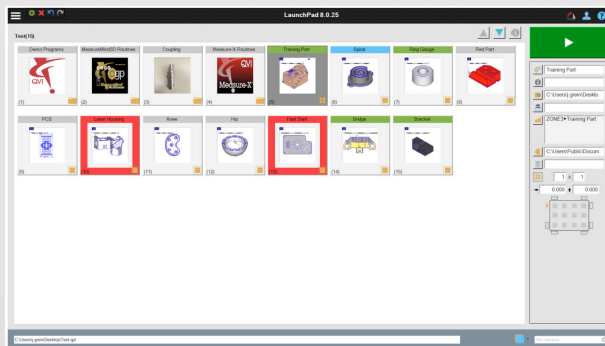

See **ZONE3 and Regulated Environments**, Part #794063-0919, for further details on how ZONE3 can help you comply with complex regulatory requirements such as FDA 21 CFR Part 11.

*US Patent No. 10 579 890



Multisensor Programming

ZONE3 Metrology Software represents a totally new way of working with multisensor measurement systems. Truly sensor independent - ZONE3 can operate SmartScope multisensor systems with any combination of video, laser, touch and scanning probes. Designed to work with any combination of sensors with no need to designate a primary sensor.

Video Sensors

Fast, non-contact video measurement provides high accuracy and repeatability for dimensions defined by edges. ZONE3 offers a wide variety of image analysis tools for feature detection and part orientation.

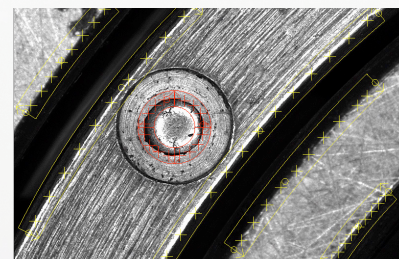

Tactile Sensors (TP20/TP200 or SP25)

Tactile sensors measure areas that cannot be seen by optics, such as cylinder interiors or sphere exteriors. Touch trigger tactile sensors find data points one at a time, while continuous contact scanning sensors offer high speed data gathering for surfaces.



Feather Probe™

Feather Probes use a specific sensing technology to determine when a resonating stylus has come close enough to a surface to dampen its resonance. This sensor can acquire a data point with only milligrams of force. Its small size makes it perfect for measuring micro-miniature or fragile components.

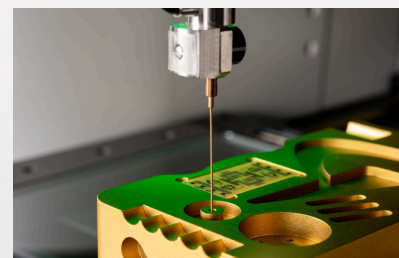

Laser Sensors (Triangulation or Interferometric)

Laser sensors excel at fast, accurate Z-axis point acquisition. Use a laser for height, depth and planar measurements, or for surface profiling on complex curves and surfaces. Laser sensors may be through-the-lens (TTL) or off-axis (DRS™). TeleStar® Interferometric sensors may be through-the-lens (TTL) or off-axis (TeleStar® Probe).

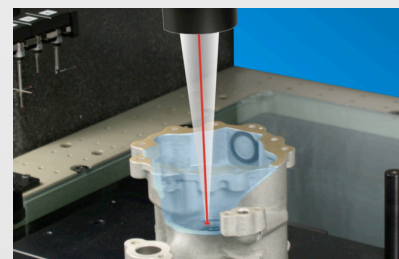

Rainbow Probe™

Chromatic white light sensors analyze the optical spectrum of reflected white light to measure surface height changes on transparent, translucent, fragile or liquid surfaces with sub-micron resolutions.

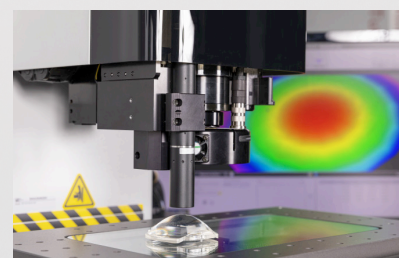

VersaFlex™*

The VersaFlex multisensor array offers up to three simultaneously available sensors on an articulating probe head on FlexPoint™ systems. With several sensors simultaneously available, there is no down time while individual sensors are exchanged from a change rack, and no need to recalibrate each time a sensor is used.



* US Patent Number 10 222 207 B2

Data Acquisition

Visual Validation: Guiding You Through the Measurement Process

ZONE3 previews offer visual validation of each operation before it's executed. You get immediate visual feedback so common errors and unintended consequences are avoided.

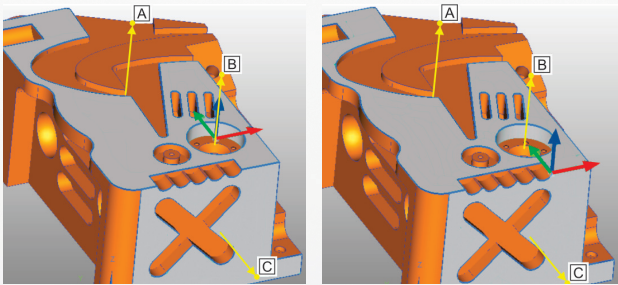

Two different outcomes based on the user's selection of Datums A-B-C (left), or A-C-B (right).

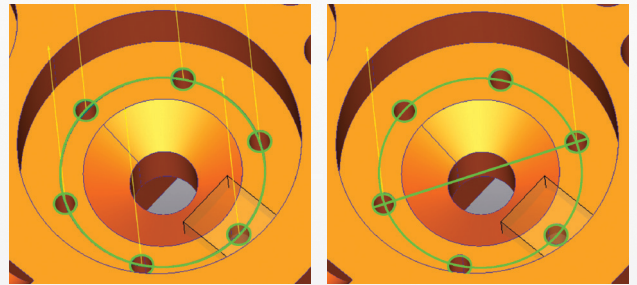

Constructions of bolt hole circle and maximum distance between two holes in that circle.

Advanced Video Tools

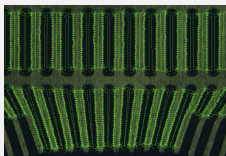

Parallel Processing combined with intelligent routine **Optimization** can be used to measure as many features as can be seen simultaneously.



The **Acquire Image** tool allows a video image to be acquired and archived, or used in a subsequent re-measurement (useful for visualization and documentation of part conditions).

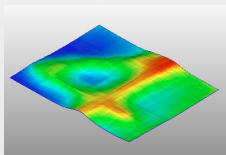

Area Multi-Focus uses optical focus to create an array of 3D data points that can be used in constructions or feature definitions.



The **Blob** finder locates irregular geometries and reports advanced results such as area, centroid, perimeter, bounding length/width, etc. in single or multiple FOV's. Also useful for searching an area of unknown defects or features.

Path Generation

ZONE3 AutoPath uses CAD nominals to automatically create an optimal path for each measurement. AutoPath is fully multisensor capable. Use AutoPath with any sensor.

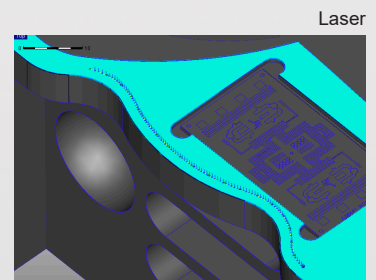
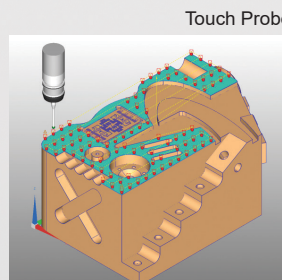
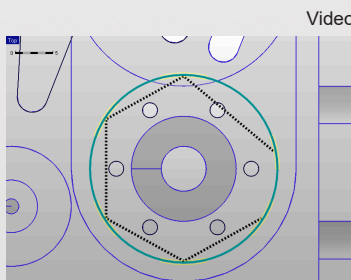

Real-Time Kinematic Model

Kinematic model simulation of the machine, parts, fixtures, and sensors, update in real time and can be used to detect potential collisions.

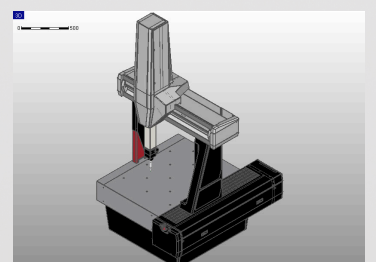



Evaluation / Reporting



- ZONE3 recognizes ASME Y14.5 and ISO 1101 standards for GD&T.
- Animated tolerance zones* allow you to visualize the specified tolerance condition.
- Specialized modules are available for Roughness, Gear, and Thread Evaluation.
- Results can be output to PDF, Excel, or graphically to truly visualize the result.
- File Output can also be used to export in any text-based format (TXT, CSV, DAT, STA, etc.) to provide raw data or point clouds for external evaluation.

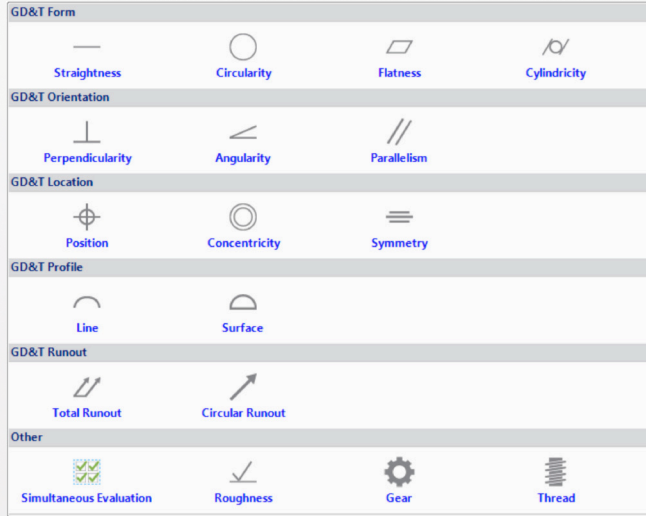

Label	Nominal	Actual	Upper Tol.	Lower Tol.	Graphics
Circle1.X	48.00000	47.99520	0.01000	-0.01000	-0.00480 (148%)
Circle1.Y	25.00000	25.00450	0.00500	-0.00500	0.00450 (90%)
Circle1.Diameter	2.00000	1.95001	0.03000	-0.03000	-0.04999 (1167%)
Circle2.X	61.50000	61.49539	0.01000	-0.01000	-0.00461 (46%)
Circle2.Y	17.20577	17.21020	0.00500	-0.00500	0.00443 (99%)
Circle2.Diameter	2.00000	1.95024	0.10000	-0.10000	-0.04976 (99%)
Circle3.X	52.50000	52.49549	0.01000	-0.01000	-0.00451 (45%)
Circle3.Y	17.20577	17.21034	0.00500	-0.00500	0.00457 (91%)
Circle3.Diameter	2.00000	1.95020	0.10000	-0.10000	-0.04980 (95%)
Circle4.X	52.50000	52.49547	0.01000	-0.01000	-0.00453 (45%)
Circle4.Y	32.79423	32.79880	0.00500	-0.00500	0.00457 (91%)
Circle4.Diameter	2.00000	1.95015	0.10000	-0.10000	-0.04985 (95%)
Circle5.X	61.50000	61.49536	0.01000	-0.01000	-0.00464 (46%)
Circle5.Y	32.79423	32.79880	0.00500	-0.00500	0.00458 (92%)
Circle5.Diameter	2.00000	1.95020	0.03000	-0.03000	-0.04980 (1166%)
Circle6.X	66.00000	65.99571	0.01000	-0.01000	-0.00429 (43%)
Circle6.Y	25.00000	25.00452	0.00500	-0.00500	0.00452 (90%)
Circle6.Diameter	2.00000	1.95011	0.10000	-0.10000	-0.04989 (95%)
Distance1.DX	18.00000	18.00050	0.00100	-0.00100	0.00050 (50%)
Distance2.DX	9.00000	8.99990	0.00100	-0.00100	-0.00010 (10%)

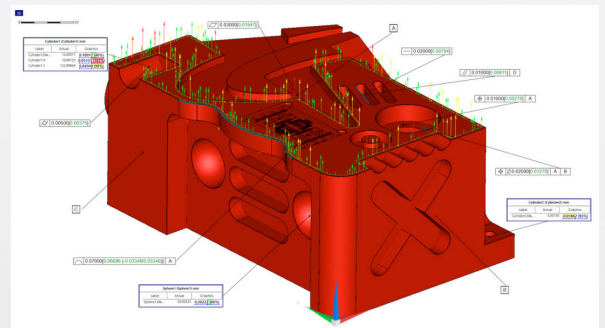

Logic / Feedback



- ZONE3's logic and feedback capabilities allow integration with your entire team to optimize the design and production processes and improve your overall quality.
- ZONE3 projects can be easily customized using user input prompts, variables, branching, and other advanced parametric programming capabilities.
- These tools provide the logic to create turnkey solutions that can easily be incorporated into automation environments with robotic integration.
- Advanced CAD tools such as replacing the model within an existing project and automatic programming of imported models with PMI (Product and Manufacturing Information) can assist you in achieving Industry 4.0 principles.

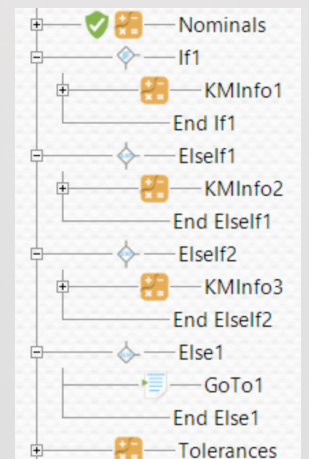
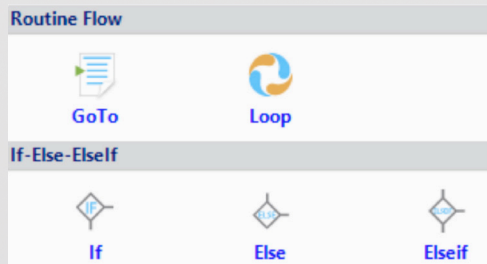
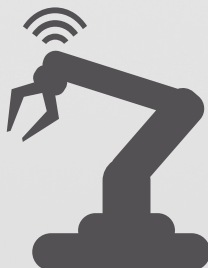

*US Patent Number 8 793 097 B2

Choose the ZONE3 Version that is Right for You

ZONE3 Versions

- **ZONE3 Express** offers full measurement capabilities and tools, basic GD&T functionality, and the ability to work with 2D CAD files.
- **ZONE3 Prime** offers all the functionality of Express, plus full 3D CAD capability and advanced GD&T functionality.
- **ZONE3 Pro** adds enhanced productivity and analysis tools for the power user.
- **ZONE3 Offline** mimics Pro, but is designed for use at an offline workstation, eliminating the need for a measuring machine for programming.

For complete details, see **ZONE3 Feature Comparison**, Part #794043-0419.

Ongoing Support

The **ZONE3 Help** system provides a convenient way to find information about ZONE3 concepts and features, tutorials with step-by-step instructions, and information of what's new in each version of ZONE3. Context-sensitive access allows you to hover the pointer over the window or control that you want help with and directly access the section where it is referenced.

Join the Community!

ZONE3.zone is the online forum for ZONE3 users. Connect with fellow ZONE3 users and OGP Application Engineers to share metrology tips and get answers to your questions about ZONE3 features – from alignments and measurement, to routine editing and reporting, and everything in between!

Through the forum, **Software Subscription Agreement (SSA)** holders can easily download the current release of ZONE3 as well as access an extensive database of ZONE3 Knowledge Documents.

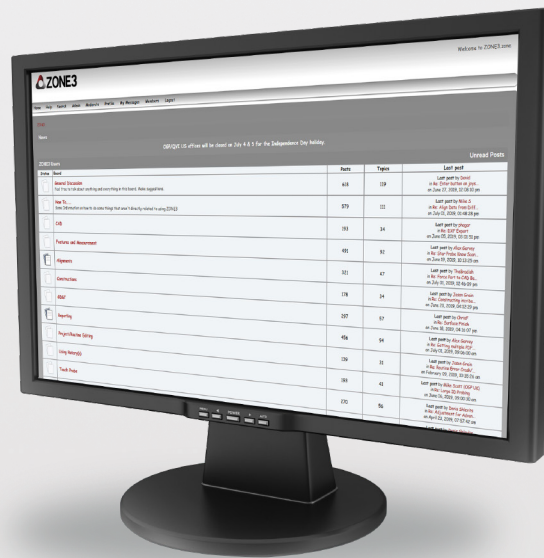

ZONE3 Availability

ZONE3 is available exclusively for new or installed OGP Multisensor Measurement Systems.

OGP authorized representatives are metrology specialists, qualified to evaluate your measurement requirements and recommend the solution that best fits your needs. Your local representative is ready to help you with product details, demonstrations, training, or purchase information.

Contact OGP to find your representative: sales@ogpnet.com



Optical Gaging Products, a division of Quality Vision International
850 Hudson Avenue • Rochester, NY 14621-4896 • USA
Phone: (585) 544-0400 • (800) 647-4243 • Fax: (585) 544-8092
info@ogpnet.com
www.ogpnet.com